

Embedding flange 500

Stainless steel embedding flange 500 is applicable for IKI Pillar heaters: 4,5 kW-6 kW.

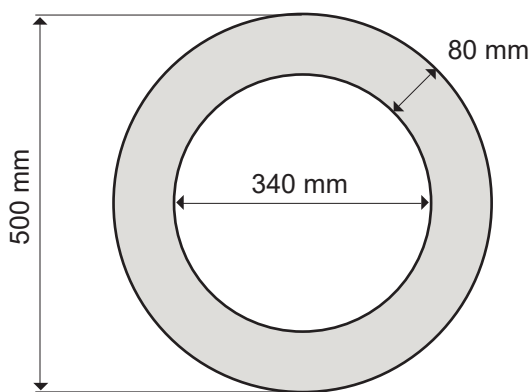

Hole for the flange
minimum 390 mm

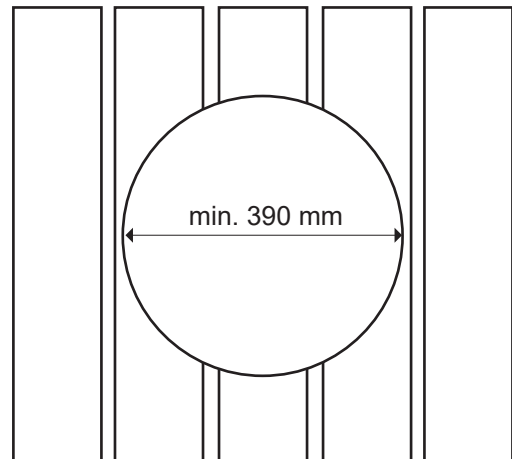

Install the flange centrally
to the bench

