

Embedding flange 680

Stainless steel embedding flange 680 is applicable for IKI Pillar heaters: 15 kW-18 kW.

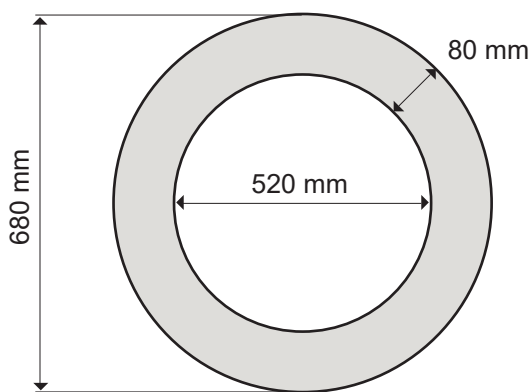

Hole for the flange
minimum 490 mm

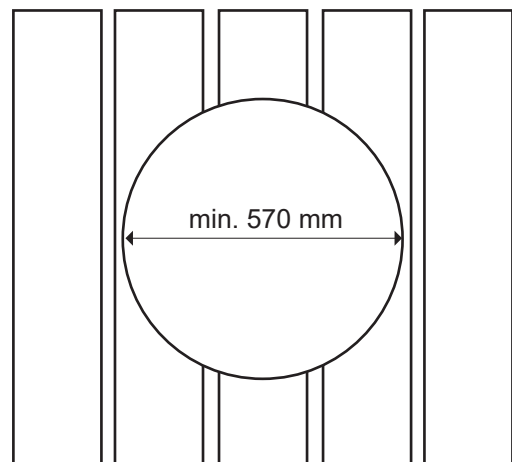

Install the flange centrally
to the bench

